

DIY-ideeënkaart

Maak bijvoorbeeld jouw eigen tas!

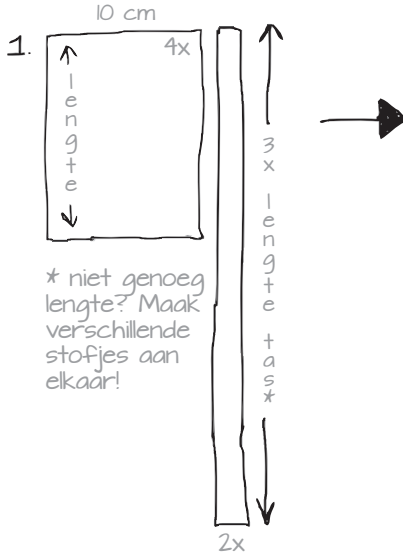

* niet genoeg lengte? Maak verschillende stofjes aan elkaar!

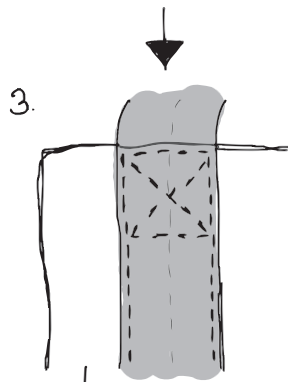
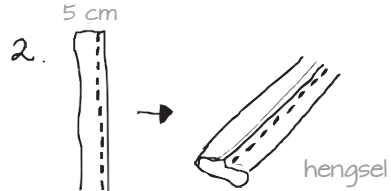

5. voering rondom aan tas naaien

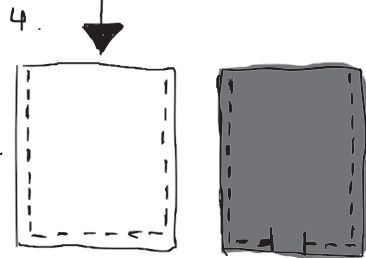
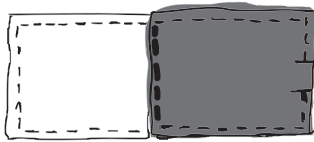

tas binnenste buiten voering binnenste buiten

6. omkeren door het geheel door de opening te halen

7.

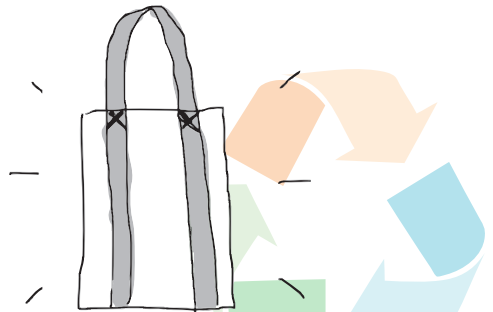
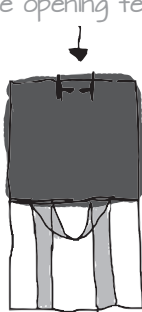

DIY-ideeënkaart

Maak bijvoorbeeld jouw eigen kussen!

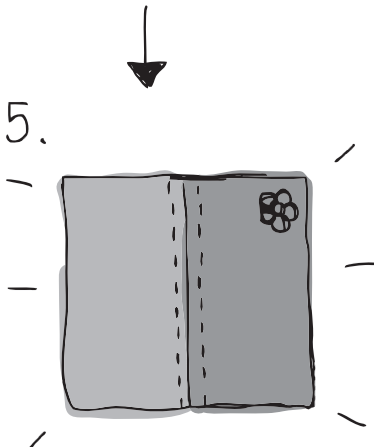
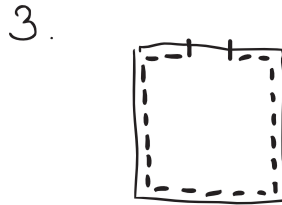
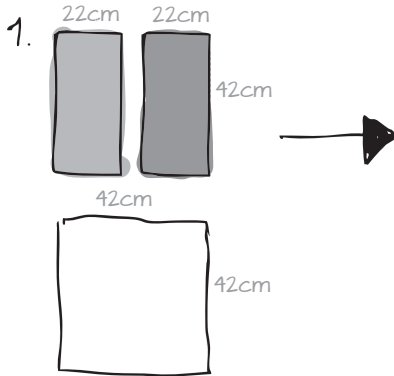

Ideetje!

versier jouw kussen met een applicatie, zoals een gehaakte bloem

